

GZ

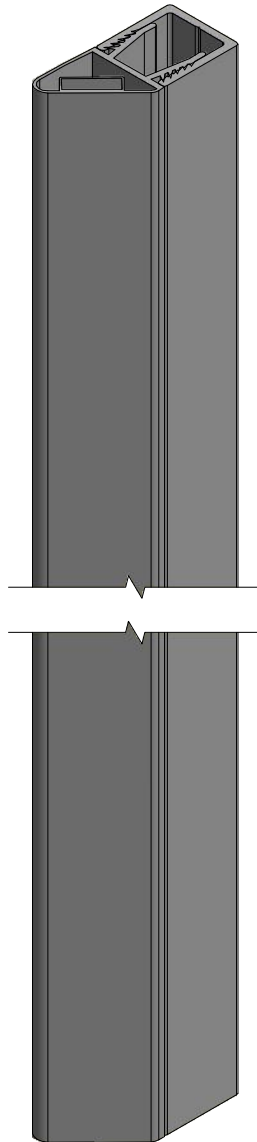

GDO1N+GZ

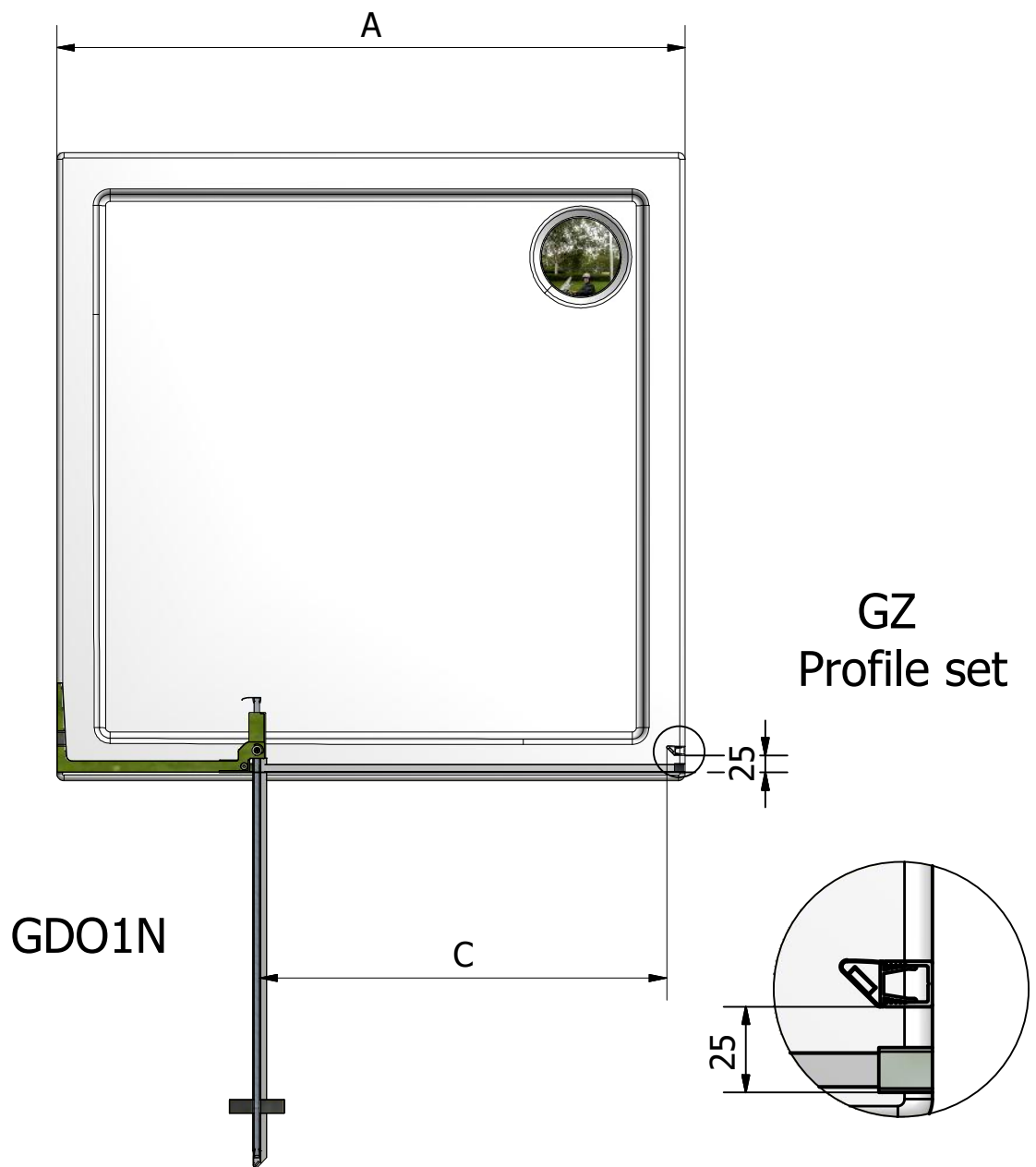

GDO1N + GZ		
Size [mm]	Installation size A [mm]	Entrance size C [mm]
700-800x2000	685-785	360-460
800-900x2000	785-885	460-560
900-1000x2000	885-985	560-660
1000-1100x2000	985-1085	660-760
1100-1200x2000	1085-1185	760-860

1. 1x
MA7181

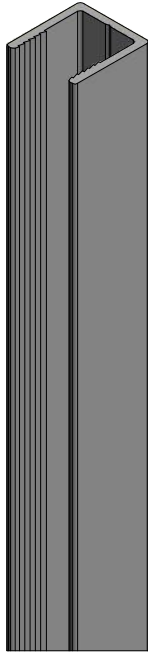

2. 1x
MA7182



3. 1x
MA8020

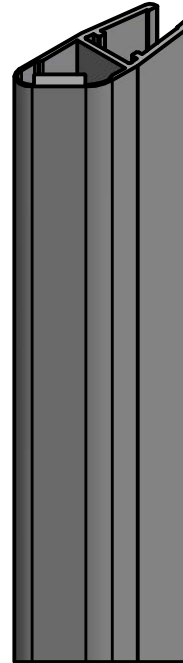

4. 3x
M0511

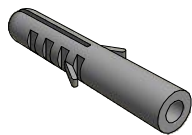

5. 3x
M0811



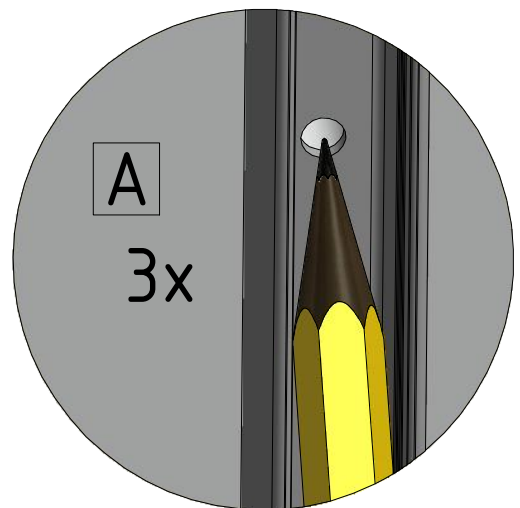
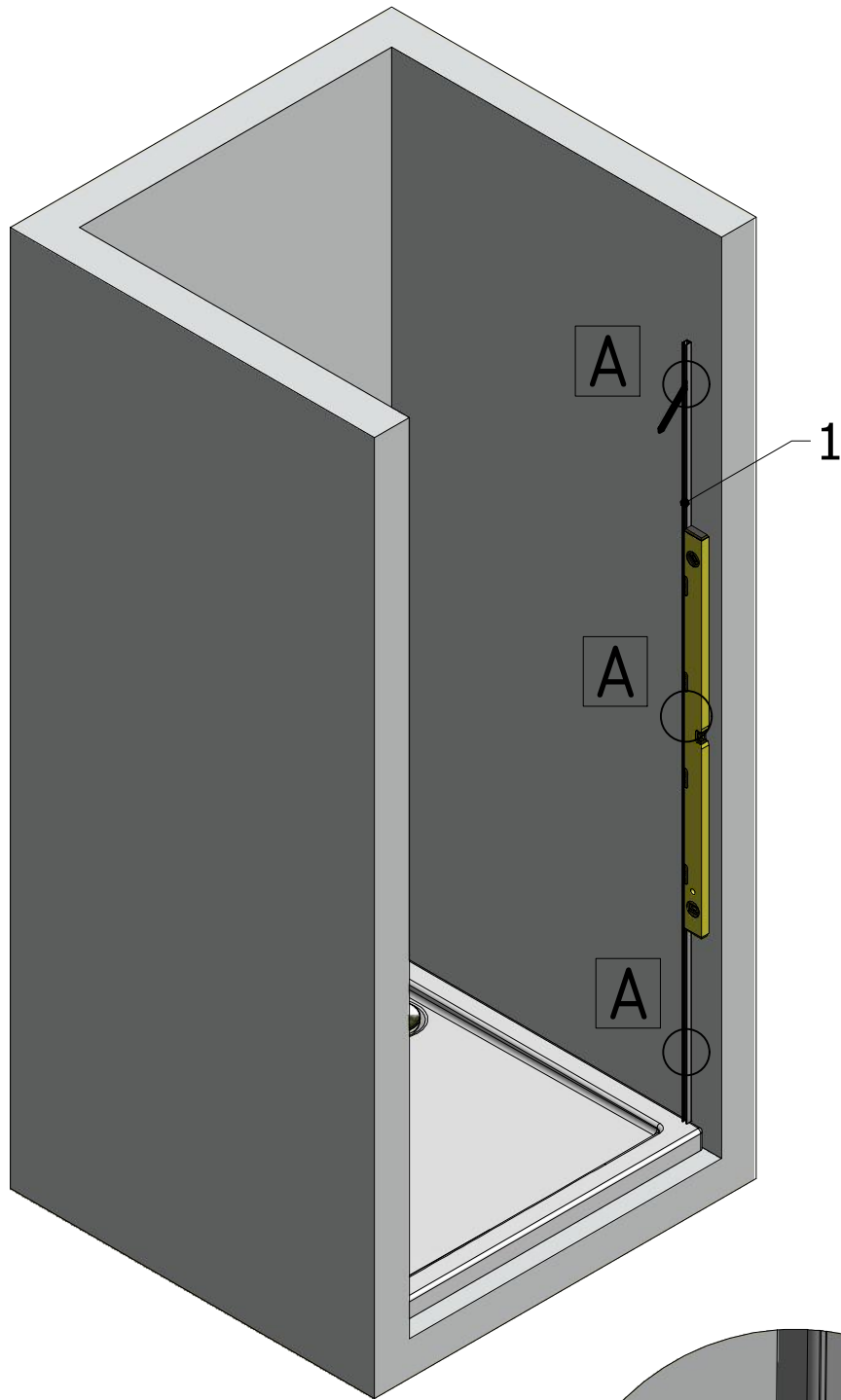

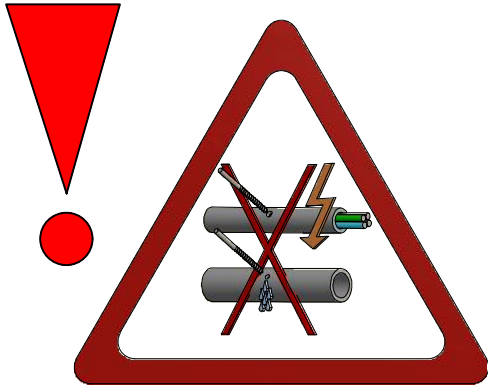

B1 3x

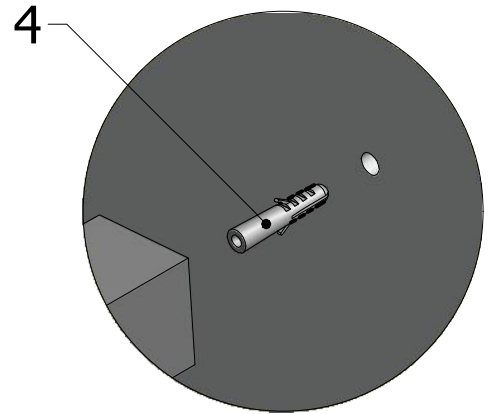
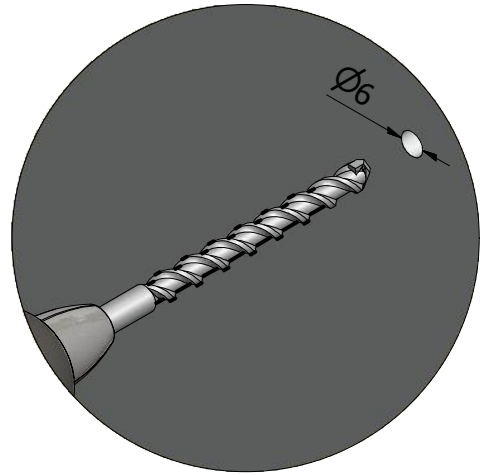

B2 3x

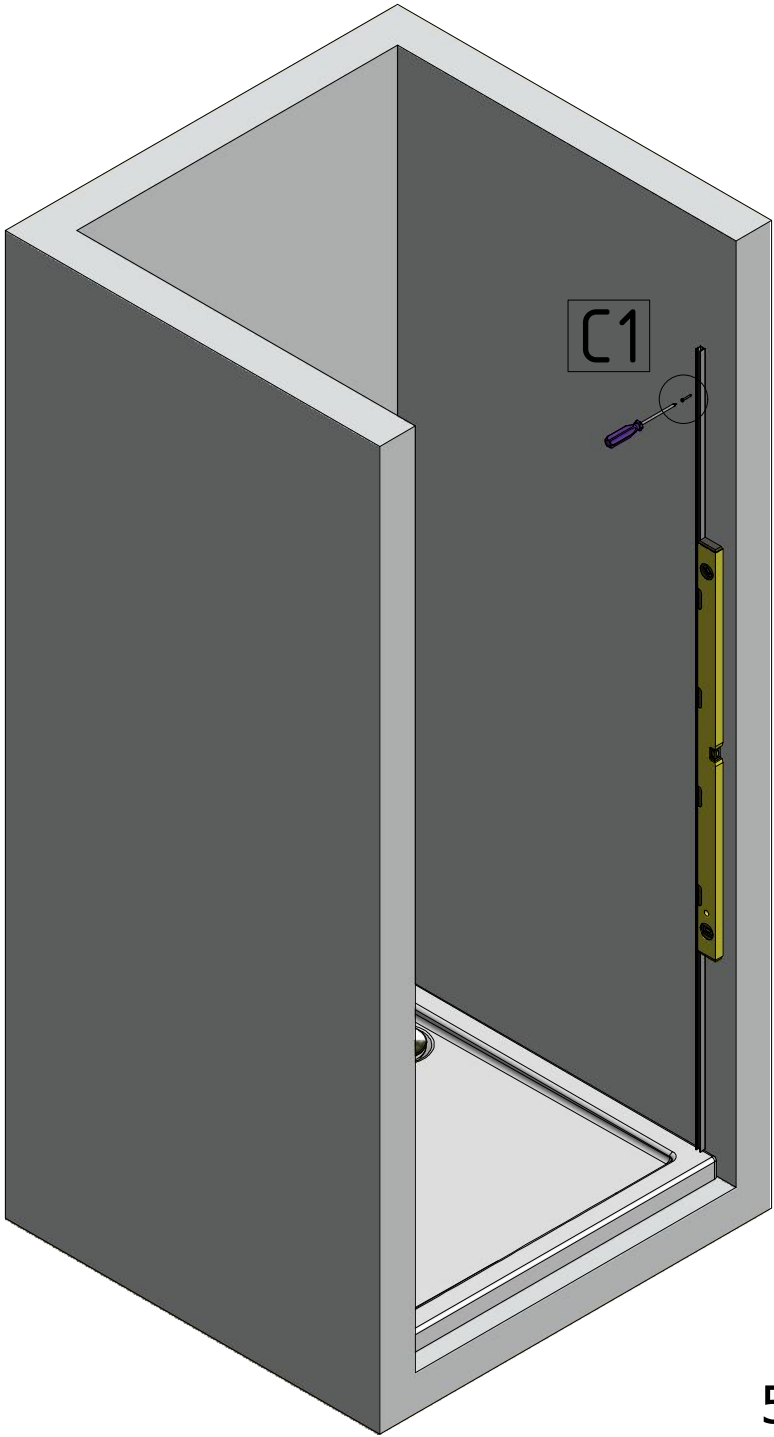

C1 3x

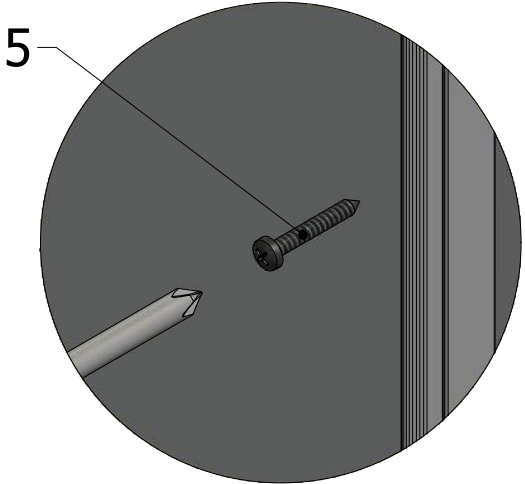

GZ+GDO1N

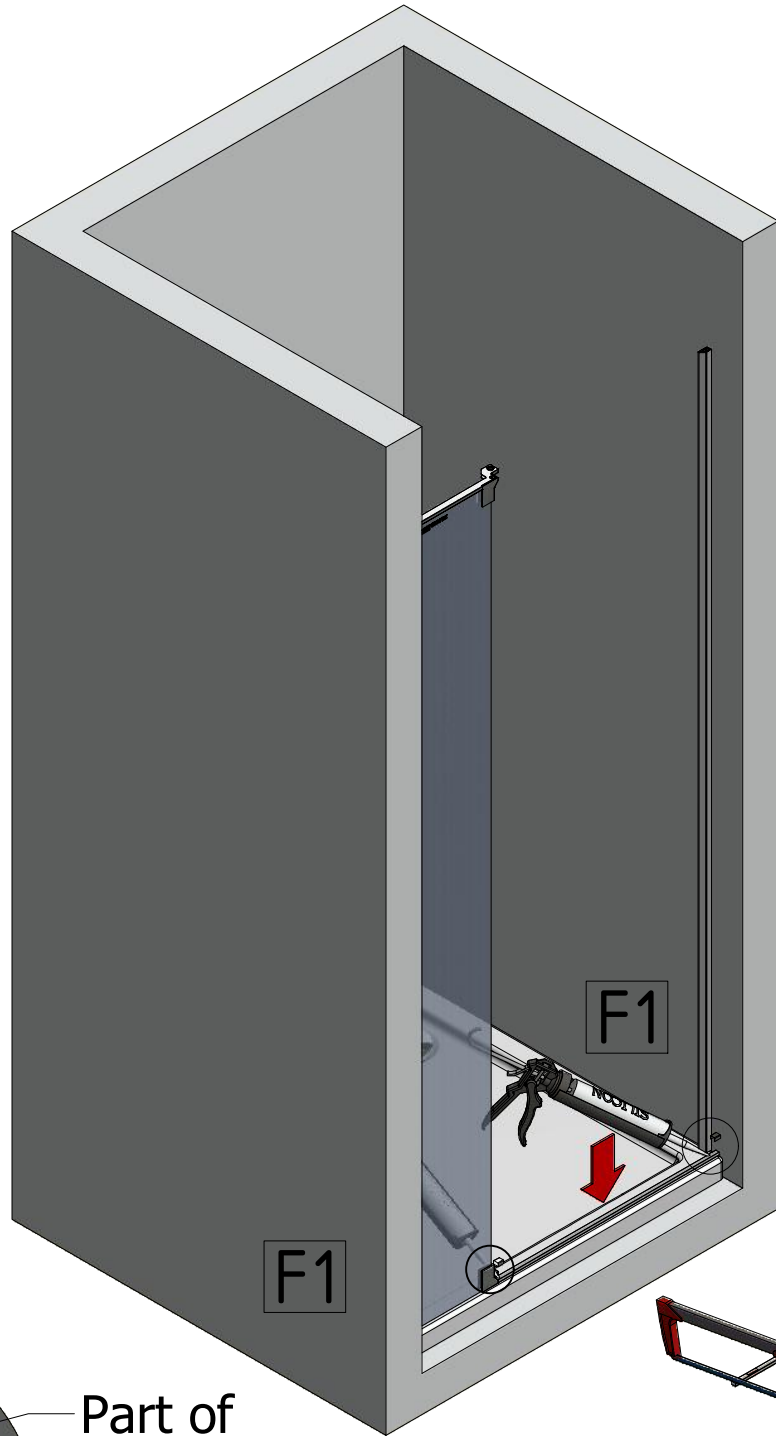

F1 2x

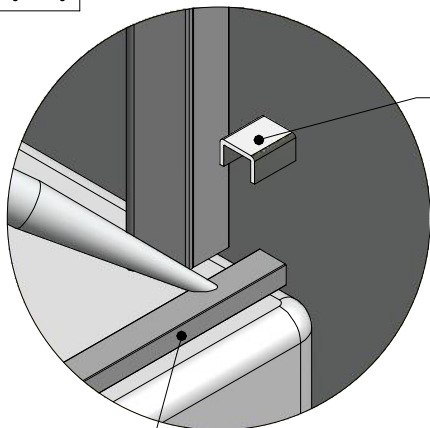

Part of
GDO1N

Part of
GDO1N

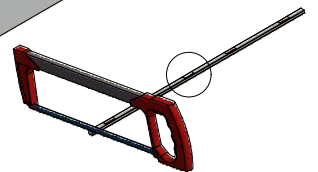

F2

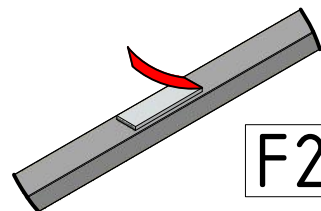

F2

Before installing remove
all sticker's cover

GZ+GDO1N

